

Volvo Construction Equipment
Building Tomorrow



L60H, L70H, L90H

Volvo Wheel Loaders 11.0-17.3 t 167-186 hp



Multitude of talents

Say hello to the latest additions to the H-Series wheel loaders: the upgraded L60H, L70H and L90H. Built on the established H-Series design, the next-generation machines are the ultimate all-rounders, offering the high quality performance you'd expect from a Volvo wheel loader, plus a host of features that promote greater versatility and stability to handle your workload.

Designed to do more

Knock heavy-duty jobs down to size with the H-Series wheel loaders. These robust workhorses offer unshakable stability thanks to the new, optimized loading unit weight and redesigned counterweight. Designed to do more, the well-balanced machines yield up to 3% higher tipping load, so you can tackle a variety of tasks – no matter how demanding.



Adapt to any application

Get the most out of your machine with a range of purpose-built attachments, including grapples, sweepers, material handling arms, snow ploughs and more. Because different jobs require different attachments, we can custom build a Volvo attachment to match your specific needs. To unlock the use of multiple attachments, simply engage the third and fourth hydraulic functions.



Fully loaded

Whatever the job, we have the tools to get it done. Volvo offers a full range of Volvo buckets, including general purpose, grading, refuse, light material, and more, to handle everything, from light material to heavy rocks. Built on decades of engineering excellence, Volvo buckets are optimized for Volvo wheel loaders and durably designed for all types of materials and tasks.



Made to match

Lift your machine's versatility to the next level with pallet forks, offering high visibility and the advantage of TP linkage and parallel movement. Ideal for pallet and material handling, Volvo forks are heavy-duty in design, allowing the wheel loader to move effortlessly around different work sites, such as yards, warehouses and harbors.



LOADED WITH VERSATILITY

Take on any application with the H-Series wheel loaders, equipped with the Torque Parallel (TP) linkage for ultimate versatility. Not only does the TP linkage offer high breakout, tilt in and lifting forces, it keeps the attachments parallel throughout the lifting range for exceptional load stability and easy bucket filling. Change tools in a matter of seconds with the Volvo attachment bracket.



“ ”

L90H: put to the test

***“Even when the machine was fully turned, it remained stable and showed no indication of tipping over.”
Test driver Sebastian Alm, Firma Sebastian Alm (Sweden)***

UP TO 20% MORE EFFICIENT

Achieve up to 20% greater fuel efficiency thanks to advanced features, such as Eco pedal and the new optional lock-up function. The lock-up feature eliminates losses in the torque converter by creating a direct drive between the engine and transmission, which work in harmony with the axles. To improve cycle times and fuel use, customize the lock-up engagement of your machine.



Drive down your costs

Get the most out of your investment with a cost-effective solution. At Volvo, we're committed to driving your operating costs down. That's why we've refined the mid-sized H-Series wheel loaders to deliver up to 20% greater fuel efficiency and optimize productivity.

Productivity up, fuel down

Cut operating costs and propel your machine's productivity with rimpull control. With the power to control the rimpull, the operator can reduce tire wear and prevent wheel spin for effective bucket filling. Select the optimum rimpull to match the application and ground conditions, and experience high productivity at low costs.

Work smarter

For the best use of engine power in all applications, rely on Smart Control, designed to optimize fuel efficiency and performance. Standard on the mid-sized H-Series wheel loaders, Smart Control ensures the correct torque in all situations for perfect harmony between the engine and hydraulics.



Do more on and off road

Do more on and off road with an increased top speed of 50km/h. Not only is the machine faster, it is also a pleasure to operate thanks to the optional lock-up feature, which improves drive response and incline performance.

Boost your profitability

Ensure a low total cost of ownership with a host of Productivity Services and Fuel Efficiency Services. From reports, training packages and consultancy solutions, Volvo has you covered – just speak to your dealer for more information.



Comfortably in control

It's not just the machine that's ready for any challenge. From the comfort and security of the spacious Volvo cab, the operator is primed for a productive work shift.

Safety as standard

Safe from the inside out, the latest loaders feature anti-slip steps and strategically placed handrails for ease of access, plus an array of seatbelt options, such as the orange three-point seatbelt. The new attachment bracket uses a visual indicator to let you know the attachment is locked and ready to use.



See more, do more

Experience a clear view of the attachment and jobsite thanks to large expanses of glass, redesigned side mirrors, rear-view camera and optional front camera. The machines also feature orange handrails and steps to stand out against the jobsite, and LED lights, available in various packages.



Take command

Customize your Volvo and take command of hydraulic functions with the optional electro servo controls. From the cab, adjust the detent third function, boom kick-out, return to dig and bucket leveling. Easily change between linear or single lever controls and select from three hydraulic settings to tailor the lever control according to your preferences.



Bucket leveling function

Take your productivity to the next level with the bucket leveling function, available when you select the optional electro hydraulic lever. The new function enhances operator performance by automatically returning the bucket from both dump and curl positions.



NO COMPROMISE ON COMFORT

Hard work has never felt so easy from the spacious of the Volvo cab, featuring your choice of comfortable operator seat, as well as ergonomic controls. Perform basic configurations using the information panel, and keep an eye on the operation with the Contronic display.



L90H: put to the test

“Everything is thought through and logical.”

Test driver Sebastian Alm, Firma Sebastian Alm (Sweden)

“In comparison to many other machines, I thought it was very quiet and comfortable inside the cab.”

Test driver Mattias Wallin, Mattias Wallin AB (Sweden)

Designed to do more

- Optimized loading unit weight, heavy-duty counterweight for greater stability
- Higher tipping load - 1.7% for L60H, 1.6% for L70H, 3% for L90H
- L90H: increased lifting height by 73mm
- Optional electro-servo controls
- New bucket leveling function

LOADED WITH VERSATILITY

- Torque Parallel linkage
- Volvo attachment bracket
- Range of purpose-built attachments
- Custom-built attachment
- 3rd and 4th hydraulic functions



Volvo Services

- Operator training
- Fuel Report
- Proactive Monitoring
- Genuine Volvo Parts

DURABLE BY DESIGN

- Improved cooling capacity
- Strong frame and central hinge
- Optional delayed engine shutdown
- Optional external axle cooling

Ultimate all-rounder



Greater access

- New cooler installation now slides out for easier cleaning
- Newly repositioned fill spouts for transmission and engine oil
- Ground-level access to service points
- Electronically-operated engine hood

Safety as standard

- Anti-slip steps and strategically placed handrails
- Orange three-point seatbelt
- Redesigned side mirrors
- Rear-view camera

UP TO 20% MORE EFFICIENT

- Optional lock-up converter
- Increased top speed of 50km/h with lock-up feature
- Rimpull control
- Smart Control
- Smooth Control
- Eco pedal

Keep your machine moving

The latest generation Volvo L60H, L70H and L90H wheel loaders extends their already legendary status by offering an upgraded portfolio of uptime-enhancing features. From simplified serviceability to proactive dealer support, you have access to everything you need to keep your machine up and moving.

Keep it cool

Count on Volvo to keep up. The improved cooling capacity regulates the component temperature, for greater machine utilization when using attachments that are demanding on the hydraulics, and longer hydraulic component life. This, plus the external axle cooling option – ideal for tough applications – doubles the axle oil change intervals for higher uptime and lower maintenance costs.



Greater access

To keep uptime high, the H-Series wheel loaders are equipped with an engine cover that opens electronically, allowing ground-level access to the service points, including the radiator. For swift and easy cleaning, the new cooler installation now slides out. Safely fill the transmission and engine oil thanks to newly repositioned fill spouts, and get back to work without delay.



Delayed engine shutdown

Reduce the wear on your engine with the new delayed engine shutdown feature. The optional function shuts off the machine when the turbo has cooled down to the ideal temperature. Not only does the feature reduce component wear, it can also be scheduled by the operator to activate automatically for added convenience.



Uptime Services

Keep your machine moving with Uptime Services, a package of solutions designed to reduce your downtime and repair costs. Proactive Monitoring, for example remotely monitors your machine's health, helping to predict potential failures before they occur. Take your pick from various Volvo Services and package them into a Volvo Services Agreement.



DURABLE BY DESIGN

Built by Volvo, for Volvo, you can count on the proven design of the latest wheel loaders to meet the demands of tough job sites. Renowned for their reliability, the next-generation H-Series wheel loaders are built with an industry-leading, strong frame, which, combined with the ideally-matched genuine Volvo drivetrain, achieves long-lasting performance.



Volvo L60H, L70H, L90H in detail

Engine

6-cylinder, 6 liters inline turbocharged diesel engine with an advanced fuel injection system with the common rail. Fuel is distributed under high pressure from a high-pressure accumulator, the rail. One belt driven high pressure pump deliver the fuel to the rail and then further on via high-pressure pipes to the electronically operated fuel injectors. Engine meets Stage V emission legislation.

L60H

Engine	Volvo	D6J
Max. power at	r/min	1 500 - 1 800
ISO 14396 gross	kW	122
	hp	166
ISO 9249, SAE J1349 net	kW	122
	hp	166
Max. torque at	r/min	1 500
SAE J1995 gross	Nm	820
ISO 9249, SAE J1349 net	Nm	820
Economic working range	r/min	800 - 1 600
Displacement	l	5.7

L70H

Engine	Volvo	D6J
Max. power at	r/min	1 400 - 1 700
ISO 14396 gross	kW	127
	hp	173
ISO 9249, SAE J1349 net	kW	127
	hp	173
Max. torque at	r/min	1 400
SAE J1995 gross	Nm	853
ISO 9249, SAE J1349 net	Nm	853
Economic working range	r/min	800 - 1 600
Displacement	l	5.8

L90H

Engine	Volvo	D6J
Max. power at	r/min	1 400 - 1 900
ISO 14396 gross	kW	137
	hp	186
ISO 9249, SAE J1349 net	kW	137
	hp	186
Max. torque at	r/min	1 400
SAE J1995 gross	Nm	934
ISO 9249, SAE J1349 net	Nm	934
Economic working range	r/min	800 - 1 600
Displacement	l	5.7

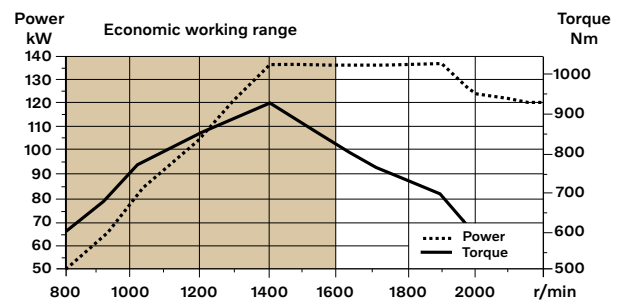
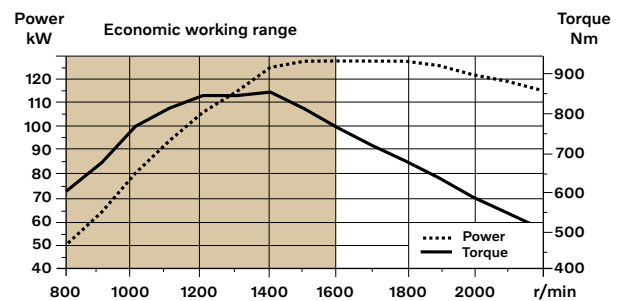
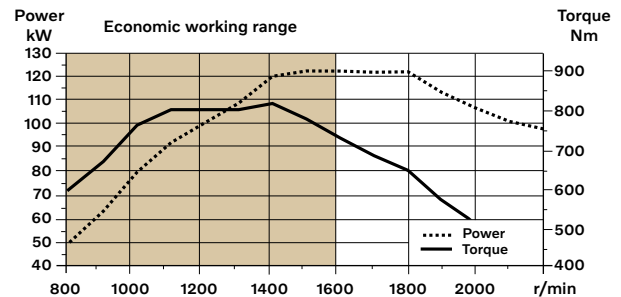

Drivetrain

Torque converter: Single-stage
Transmission: Volvo countershaft transmission with single lever control. Fast and smooth shifting of gears with Pulse Width Modulation (PWM) valve.
Transmission: Volvo Automatic Power Shift (APS) gear shifting system with fully automatic shifting 1-4 and mode selector with 4 different gear shifting programs, including AUTO mode.
Axles: Volvo fully floating axle shafts with planetary hub reductions and cast steel axle housing. Fixed front axle and oscillating rear axle. 100% differential lock on the front axle.

L60H

Transmission	Volvo	HTE 125C Non Lock-up / HTE 125 Lock-up
Torque multiplication, stall ratio		2.5:1 Non Lock-up / 2.59:1 Lock-up
Maximum speed		
1st gear	km/h	Converter 7.5 / Lock-up 7.5
2nd gear	km/h	Converter 15 / Lock-up 15
3rd gear	km/h	Converter 28 / Lock-up 29
4th gear	km/h	Converter 46 / Lock-up 50
4th gear: Shown in speedometer and limited by ECU		
Measured with tires 20.5R25		
Front axle/rear axle AWB 15/AWB 15		
Rear axle oscillation	± °	13
Ground clearance	mm	470
at oscillation	°	13

L70H

Transmission	Volvo	HTE 125C Non Lock-up / HTE 125 Lock-up
Torque multiplication, stall ratio		2.5:1 Non Lock-up / 2.59:1 Lock-up
Maximum speed		
1st gear	km/h	Converter 7.5 / Lock-up 7.5
2nd gear	km/h	Converter 15 / Lock-up 15
3rd gear	km/h	Converter 29 / Lock-up 30
4th gear	km/h	Converter 46 / Lock-up 50
4th gear: Shown in speedometer and limited by ECU		
Measured with tires 20.5R25		
Front axle/rear axle AWB 25/AWB 20		
Rear axle oscillation	± °	13
Ground clearance	mm	470
at oscillation	°	13

L90H

Transmission	Volvo	HTE 125C Non Lock-up / HTE 125 Lock-up
Torque multiplication, stall ratio		2.5:1 Non Lock-up / 2.59:1 Lock-up
Maximum speed		
1st gear	km/h	Converter 6.5 / Lock-up 6.5
2nd gear	km/h	Converter 14 / Lock-up 14
3rd gear	km/h	Converter 26 / Lock-up 27
4th gear	km/h	Converter 46 / Lock-up 50
4th gear: Shown in speedometer and limited by ECU		
Measured with tires 20.5R25		
Front axle/rear axle AWB 25/AWB 20		
Rear axle oscillation	± °	13
Ground clearance	mm	470
at oscillation	°	13

Electrical system

Contronic electrical system with central warning light and buzzer for following functions: - Serious engine fault, Low steering system pressure, Over speed warning engine, Interruption in communication (computer fault), Central warning light and buzzer with the gear engaged for the following functions: Low engine oil pressure, High engine oil temperature, High charge air temperature, Low coolant level, High coolant temperature, High crank case pressure, Low transmission oil pressure, High transmission oil temperature, Low brake pressure, Engaged parking brake, Fault on brake charging, Low hydraulic oil level, High hydraulic oil temperature, Overspeeding in engaged gear, High brake cooling oil temperature front and rear axles, etc.

		L60H	L70H	L90H
Batteries	V	2 x 12	2 x 12	2 x 12
Battery capacity	Ah	2 x 110	2 x 110	2 x 110
Cold cranking capacity, approx	A	680	680	680
Alternator rating	W/A	3 135/80	3 135/80	3 135/80
Starter motor output	kW	5.5	5.5	5.5

Brake system

Service brake: Volvo dual-circuit system with outboard mounted, hydraulically operated, fully sealed and circulating oil cooled wet disc brakes. Four operator selectable transmission disengagement settings while braking.
Parking brake: Dry disc brake mounted on the transmission output shaft. Applied by spring force, electro-hydraulically released with a switch on the instrument panel.
Secondary brake: Dual brake circuits with rechargeable accumulators.
Standard: The brake system complies with the requirements of ISO 3450, 71/320/EEC

		L60H	L70H	L90H
Number of brake discs per wheel		1.00	1.00	1.00
Accumulators	l	3 x 0.5	2 x 0.5+1 x 1.0	2 x 0.5+1 x 1.0
Accumulators for parking brake	l	1 x 0.5	1 x 1.0	1 x 1.0

Volvo L60H, L70H, L90H in detail

Cab

Instrumentation: All important information is centrally located in the operator's field of vision. Display for Contronic monitoring system.
 Heater and defroster: Heater coil with filtered fresh air and fan with auto and 11 manual speed settings. Defroster vents for all window areas.
 Operator's seat: Operator's seat with adjustable air suspension and retractable seatbelt. The seat is mounted on a bracket on the rear cab wall and floor. The forces from the retractable seatbelt are absorbed by the seat rails.
 Standards: The cab is tested and approved according to ROPS (ISO 3471), FOPS (ISO 3449). The cab meets with requirements according to ISO 6055 (Operator overhead protection - Industrial trucks) and SAE J386 (Operator Restraint System).

		L60H	L70H	L90H
Emergency exit: Use emergency hammer to break window				
Ventilation	m ³ /min	9	9	9
Heating capacity	kW	16	16	16
Air conditioning (optional)	kW	7.5	7.5	7.5

Sound Level

		L60H	L70H	L90H
Sound pressure level in cab according to ISO 6396				
L _{pa}	dB	68	68	68
External sound level according to ISO 6395 and EU Noise Directive 2000/14/EC				
L _{WA}	dB	104	105	105

Lift Arm System

Torque parallel linkage (TP-linkage) with high breakout torque and parallel lift-arm action.

		L60H	L70H	L90H
Lift cylinders		2	2	2
Cylinder bore	mm	110	110	120
Piston rod diameter	mm	70	70	70
Stroke	mm	665	756	744
Tilt cylinder		1	1	1
Cylinder bore	mm	150	160	180
Piston rod diameter	mm	80	90	90
Stroke	mm	444	432	430

Hydraulic system

Closed center load sensing hydraulic system with non pressurised hydraulic tank and pilot operated control valves.
 System supply: Variable displacement axial piston pump supply the hydraulic system.
 Valves: The central valve distributes pressure and flow out to the cooling fan, steering, brake, pilot and hydraulic system. Steering system gets priority over others.
 Lift function: The valve has four positions; raise, hold, lower and float position. Automatic boom kickout position can be set to any position between maximum reach and full lifting height.
 Tilt function: The valve has three functions; rollback, hold and dump. Automatic tilt out/tilt in can be adjusted to the desired bucket angle.
 Cylinders: Double-acting cylinders for all functions.
 Filter: Full flow filtration through 10 micron (absolute) filter cartridge.

		L60H	L70H	L90H
Working pressure maximum, pump 2 for steering-, brake-, pilot- and working hydraulic system	MPa	26	26	31
Flow	l/min	145	154	171
at	MPa	10	10	10
engine speed	r/min	1900	1900	1900
Working pressure maximum, pump 3 for brake- and cooling fan system	MPa	21	21	21
Flow	l/min	33	33	33
at	MPa	10	10	10
engine speed	r/min	1900	1900	1900
Pilot system, working pressure	MPa	3.5	3.5	3.5
Cycle times				
Lift	s	4.5	5.1	5.4
Tilt	s	2.3	1.3	1.9
Lower, empty	s	2.9	2.7	3.2
Total cycle time	s	9.7	9.1	10.5

Steering System

System supply: The steering system has priority feed from a load-sensing axial piston pump with variable displacement.
 Steering cylinders: Two double-acting cylinders.

		L60H	L70H	L90H
Steering cylinders		2	2	2
Cylinder bore	mm	70	70	80
Rod diameter	mm	45	45	50
Stroke	mm	386	386	345
Working pressure	MPa	21	21	21
Maximum flow	l/min	60	60	60
Maximum articulation	± °	40	40	40

Service Refill

Service accessibility: Large, electrically operated easy-to-open hood covering whole engine compartment. Fluid filters and component breather air filters are located from ground level access and promote long service intervals. Machine contronics have possibility to monitor, log and analyze data to facilitate troubleshooting.

		L60H	L70H	L90H
Fuel tank	l	222	222	222
DEF/AdBlue® tank	l	20	20	20
Engine coolant	l	30	30	30
Hydraulic oil tank	l	90	90	90
Transmission oil (non lock-up)	l	21	21	21
Transmission oil (lock-up)	l	22	22	22
Engine oil	l	20	20	20
Axle oil front	l	25	35	35
Axle oil rear	l	25	27	27

Specifications

Tires 20.5 R25 L3

		L60H	L70H	L90H	L60H	L70H	L90H
		Standard boom			Long boom		
B	mm	6 010	6 080	6 170	6 520	6 560	6 600
C	mm	3 000	3 000	3 050	3 000	3 000	3 050
D	mm	440	450	450	430	450	440
F	mm	3 270	3 280	3 280	3 270	3 280	3 280
G	mm	2 133	2 134	2 132	2 134	2 134	2 132
J	mm	3 550	3 580	3 730	4 080	4 050	4 140
K	mm	3 870	3 870	4 040	4 380	4 350	4 460
O	°	56	56	57	56	52	58
Pmax	°	45	46	45	42	45	44
R	°	43	43	44	45	44	47
R1*	°	46	48	49	50	49	53
S	°	79	68	67	79	73	65
T	mm	123	106	112	150	112	123
U	mm	410	450	480	590	500	570
X	mm	1 900	1 930	1 960	1 900	1 930	1 960
Y	mm	2 430	2 460	2 490	2 430	2 460	2 490
Z	mm	3 210	3 160	3 460	3 590	3 500	3 910
a ₂	mm	5 340	5 350	5 430	5 340	5 350	5 430
a ₃	mm	2 900	2 890	2 940	2 900	2 890	2 940
a ₄	±°	40	40	40	40	40	40

* Carry position SAE

**Calculated with additional protective guarding

Where applicable, specifications and dimensions are according to ISO 7131, SAE J732, ISO 7546, SAE J742, ISO 14397, SAE J818

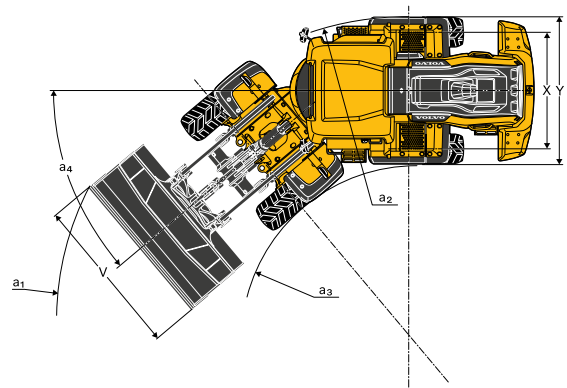
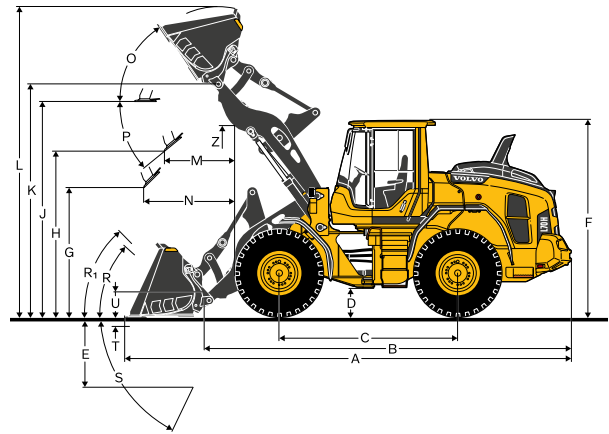

Tires: 20.5R25 L3

		L60H	L70H	L90H
SAE-Load	kg	3 450	3 990	4 600
Operating weight without load*	kg	12 883	14 585	16 645
Grapple sales code		82 194	80 153	80 832
A	m ²	1.3	1.5	2.4
B	mm	3 412	3 380	3 487
C	mm	1 483	1 594	1 703
D	mm	2 929	2 870	2 865
E	mm	1 175	1 265	1 319
F	mm	1 532	1 502	1 441
G	mm	2 350	2 442	2 740
H	mm	4 333	4 378	4 613
I	mm	5 878	6 027	6 664
J	mm	1 997	2 141	2 786
K	mm	2 080	2 365	2 990
L	mm	1 709	1 800	2 131
M	mm	7 861	7 996	8 469

* Calculated with additional protective guarding

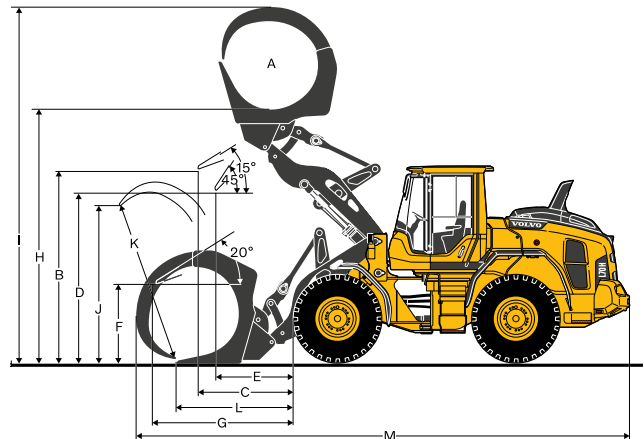

Specifications

Tires: 20.5R25 L3

		L60H	L70H	L90H
Material handling arm sales code		92007	92007	92008
A*	kg	1 800	2 150	2 760
B*	kg	1 400	1 710	2 130
C*	kg	1 150	1 400	1 740
Static tipping load, straight	kg	3 238	3 583	4 289
35deg. Turn	kg	2 910	3 222	3 834
at full turn	kg	2 814	3 116	3 700
D	mm	2 592	2 716	2 486
E	mm	2 002	2 106	1 894
F	mm	1 465	1 549	1 301
G	mm	3 270	3 323	3 253
H	mm	4 305	4 358	4 387
I	mm	5 439	5 492	5 520
J	mm	905	1 269	1 339
K	mm	1 227	1 744	1 889
L	mm	1 580	2 266	2 439
M	mm	2 258	2 176	2 051
N	mm	3 241	3 095	3 043
O	mm	4 319	4 102	4 034
P	mm	1 512	1 523	1 520
Q	mm	5 286	5 302	5 403
R	mm	6 171	6 174	6 370
S	mm	7 139	7 129	7 336

Operating weight without load kg 11 885 13 451 14 833

* Op. load at full turn + tipping position

Tipping loads calculated for max. arm length

**Calculated with additional protective guarding

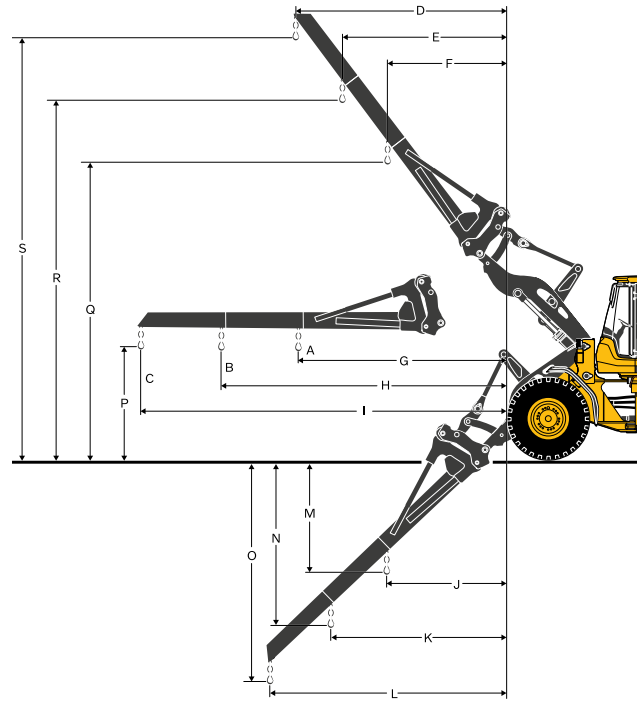

Tires: 20.5R25 L3

		L60H	L70H	L90H
Fork frame sales code		83768	83768	83770
Fork tines sales code (R/L)		80042/80043	80042/80044	80106/80107
Static tipping load, straight	kg	6 930	7 576	8 904
35deg. Turn	kg	6 230	6 809	7 947
at full turn	kg	6 024	6 584	7 664
at load center distance*	mm	600	600	600
A	mm	798	841	932
B	mm	1 567	1 616	1 679
C	mm	-38	-52	-4
D	mm	1 831	1 859	1 800
E	mm	3 713	3 736	3 841
F	mm	700	767	641
Operating weight without load	kg	11 965	13 531	14 928





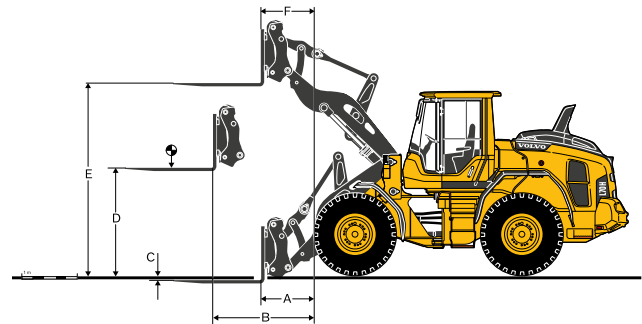



* Firm and level ground

**Calculated with additional protective guarding



Volvo L60H specifications

L60H*

	BR 20,5R25 VJT L3	GENERAL PURPOSE						GRADING	LIGHT MATERIAL		LONG BOOM
		 1.8 m³ STE H T	 1.9 m³ STE H BOE	 2.1 m³ STE P BOE	 2.1 m³ STE H BOE	 2.3 m³ STE P BOE	 2.3 m³ STE H BOE	 1.7 m³ GRB H BOE	 3.1 m³ LM H	 5 m³ LM H	
Volume, heaped ISO/SAE	m³	1.8	1.9	2.1	2.1	2.3	2.3	1.7	3.1	5.0	0
Volume at 110% fill factor	m³	2.0	2.1	2.3	2.3	2.5	2.5	1.9	3.4	5.5	0
Static tipping load, straight	kg	9 020	8 860	9 270	8 760	9 190	8 650	7 750	8 460	8 470	-1 820
at 35° turn	kg	8 080	7 930	8 320	7 830	8 240	7 730	6 930	7 550	7 520	-1 680
at full turn	kg	7 800	7 650	8 040	7 560	7 960	7 460	6 690	7 280	7 250	-1 640
Breakout force	kN	84.9	80.2	82.9	76.1	79.0	72.8	60.2	61.7	53.8	8.0
A	mm	7 410	7 340	7 300	7 400	7 370	7 470	7 650	7 680	7 910	520
E	mm	1 190	1 140	1 110	1 200	1 160	1 260	1 400	1 480	1 700	50
H	mm	2 750	2 800	2 820	2 760	2 780	2 720	2 510	2 580	2 430	550
L	mm	5 110	5 110	5 120	5 170	5 190	5 240	4 530	5 280	5 480	510
M	mm	1 070	1 050	1 020	1 090	1 060	1 140	1 130	1 320	1 500	20
N	mm	1 580	1 590	1 570	1 610	1 590	1 630	1 490	1 630	1 670	450
V	mm	2 500	2 500	2 500	2 500	2 500	2 500	2 500	2 550	2 650	0
a1 clearance circle	mm	11 800	11 760	11 760	11 800	11 800	11 840	12 140	12 010	12 240	480
Operating weight	kg	12 260	12 320	12 120	12 360	12 160	12 400	12 260	12 450	12 740	230

*Calculated with additional protective guarding.

Bucket Selection Chart

The chosen bucket is determined by the density of the material and the expected bucket fill factor. The actual bucket volume is often larger than the rated capacity, due to the features of the TP linkage, including an open bucket design, good rollback angles in all positions and good bucket filling performance. The example represents a standard boom configuration. Example: Sand and gravel. Fill factor ~ 105%. Density 1.65 t/m³. Result: The 1.9 m³ bucket carries 2.0 m³. For optimal stability always consult the bucket selection chart.

Material	Bucket fill, %	Material density, t/m ³	ISO/SAE bucket volume, m ³	Actual volume, m ³
Earth/Clay	~ 110	~ 1.55	1.9	2.1
		~ 1.40	2.1	2.3
		~ 1.30	2.3	2.5
Sand/Gravel	~ 105	~ 1.65	1.9	2.0
		~ 1.50	2.1	2.2
		~ 1.35	2.3	2.1
Aggregate	~ 100	~ 1.75	1.9	1.9
		~ 1.55	2.1	2.1
		~ 1.55	2.3	2.3
Rock	≤100	~ 1.70	1.7	1.7

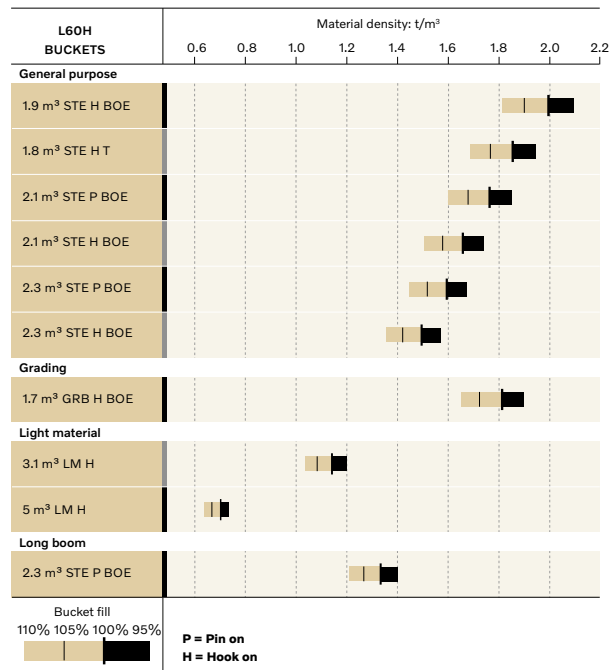

How to read bucket fill factor









Supplemental Operating Data

Tires 20.5 R25 L3		Standard boom			Long boom
		17.5 R25 L2	20.5 R25 L2	600/65 R25 L3	600/65 R25 L3
Width over tires	mm	-130	+8	+96	+96
Ground clearance	mm	-68	-10	-30	-22
Tipping load, full turn	kg	-337	-166	-72	0
Operating weight	kg	-544	-112	+8	+3

Calculated with 2.3 m³ STE P BOE, additional protective guarding

Volvo L70H specifications

L70H*

BR 20,5R25 VJT L3	GENERAL PURPOSE						GRADING	LIGHT MATERIAL		LONG BOOM	
											
	2.1 m³ STE H BOE	2.3 m³ STE H T	2.3 m³ STE P BOE	2.3 m³ STE H BOE	2.4 m³ STE P BOE	2.4 m³ STE H BOE	2.2 m³ GRB H BOE	3.4 m³ LM H	6.4 m³ LM H		
Volume, heaped ISO/SAE	m³	2.1	2.3	2.3	2.3	2.4	2.4	2.2	3.4	6.4	0
Volume at 110% fill factor	m³	2.3	2.5	2.5	2.5	2.6	2.6	2.4	3.7	7.0	0
Static tipping load, straight	kg	9 750	9 640	10 280	9 680	10 240	9 640	7 930	9 270	8 840	-1870
at 35° turn	kg	8 720	8 620	9 220	8 650	9 180	8 610	7 050	8 260	7 810	-1720
at full turn	kg	8 420	8 310	8 910	8 340	8 870	8 310	6 790	7 960	7 500	-1670
Breakout force	kN	90.3	87.0	97.2	88.2	93.5	85.1	62.8	71.8	53.9	-1.7
A	mm	7 480	7 610	7 400	7 510	7 450	7 570	7 960	7 780	8 330	470
E	mm	1 180	1 290	1 100	1 210	1 150	1 260	1 670	1 470	1 970	30
H	mm	2 760	2 670	2 810	2 730	2 780	2 700	2 350	2 530	2 150	480
L	mm	5 220	5 280	5 190	5 250	5 250	5 320	4 720	5 450	5 780	470
M	mm	1 140	1 200	1 070	1 160	1 110	1 190	1 350	1 340	1 730	-40
N	mm	1 650	1 660	1 610	1 660	1 630	1 670	1 570	1 680	1 730	400
V	mm	2 550	2 550	2 650	2 650	2 550	2 550	2 650	2 650	2 750	0
a ₁ clearance circle	mm	11 850	11 930	11 910	11 960	11 850	11 900	12 480	12 140	12 600	430
Operating weight	kg	13 960	14 020	13 750	14 010	13 770	14 020	14 260	14 210	14 750	260

*Calculated with additional protective guarding.

Bucket Selection Chart

The chosen bucket is determined by the density of the material and the expected bucket fill factor. The actual bucket volume is often larger than the rated capacity, due to the features of the TP linkage, including an open bucket design, good rollback angles in all positions and good bucket filling performance. The example represents a standard boom configuration. Example: Sand and gravel. Fill factor ~ 105%. Density 1.65 t/m³. Result: The 1.9 m³ bucket carries 2.0 m³. For optimal stability always consult the bucket selection chart.

Material	Bucket fill, %	Material density, t/m ³	ISO/SAE bucket volume, m ³	Actual volume, m ³
Earth/Clay	~ 110	~ 1.55	2.1	2.3
		~ 1.45	2.3	2.6
		~ 1.40	2.4	2.6
Sand/Gravel	~ 105	~ 1.60	2.1	2.2
		~ 1.50	2.3	2.4
		~ 1.45	2.4	2.5
Aggregate	~ 100	~ 1.80	2.1	2.1
		~ 1.70	2.3	2.3
		~ 1.60	2.4	2.4
Rock	≤100	~ 1.70	1.6	1.6

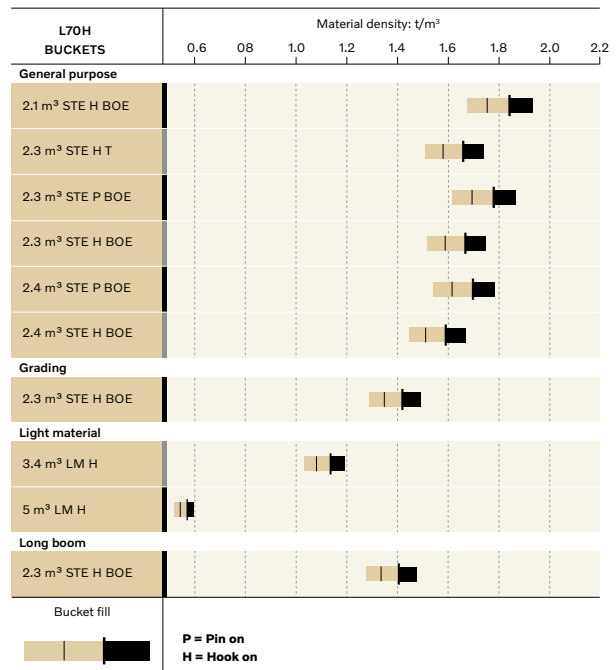

How to read bucket fill factor









Supplemental Operating Data

Tires 20.5 R25 L3	Standard boom		Long boom
	20.5 R25 L2	600/65 R25 L3	600/65 R25 L3
Width over tires	mm	+8	+96
Ground clearance	mm	-8	-24
Tipping load, full turn	kg	-62	+9
Operating weight	kg	-113	+4

Calculated with 2,3 m³ STE H BOE, additional protective guarding

Volvo L90H specifications

L90H*

BR 20,5R25 VJT L3	GENERAL PURPOSE						GRADING	LIGHT MATERIAL		LONG BOOM
										
	2.3 m³ STE H BOE	2.5 m³ STE H T	2.5 m³ STE P BOE	2.5 m³ STE H BOE	2.6 m³ STE P BOE	2.8 m³ STE P BOE	2.8 m³ GRB H BOE	4.1 m³ LM H	7 m³ LM H	
Volume, heaped ISO/SAE	m³	2.3	2.5	2.5	2.5	2.6	2.8	4.1	7.0	0
Volume at 110% fill factor	m³	2.5	2.8	2.8	2.8	2.9	3.1	4.5	7.7	0
Static tipping load, straight	kg	11 410	11 330	11 940	11 320	11 820	11 910	9 260	10 820	10 530
at 35° turn	kg	10 120	10 030	10 620	10 030	10 500	10 580	8 190	9 550	9 250
at full turn	kg	9 730	9 650	10 220	9 650	10 110	10 190	7 870	9 180	8 870
Breakout force	kN	134.9	129.9	141.3	127.1	133.8	135.6	92.2	100.7	87.0
A	mm	7 600	7 850	7 550	7 690	7 630	7 610	8 170	8 050	8 350
E	mm	1 200	1 410	1 150	1 280	1 220	1 200	1 760	1 600	1 860
H	mm	2 890	2 730	2 920	2 830	2 870	2 880	2 400	2 610	2 410
L	mm	5 450	5 510	5 440	5 530	5 520	5 500	4 900	5 630	5 840
M	mm	1 010	1 170	960	1 070	1 020	1 000	1 210	1 350	1 560
N	mm	1 670	1 720	1 650	1 700	1 670	1 660	1 520	1 710	1 710
V	mm	2 650	2 650	2 650	2 500	2 500	2 750	2 880	2 750	3 000
a ₁ clearance circle	mm	12 140	12 290	12 130	12 060	12 040	12 250	12 980	12 500	12 920
Operating weight	kg	15 560	15 630	15 380	15 600	15 390	15 360	15 700	15 850	16 280

*Calculated with additional protective guarding.

Bucket Selection Chart

The chosen bucket is determined by the density of the material and the expected bucket fill factor. The actual bucket volume is often larger than the rated capacity, due to the features of the TP linkage, including an open bucket design, good rollback angles in all positions and good bucket filling performance. The example represents a standard boom configuration. Example: Sand and gravel. Fill factor ~ 105%. Density 1.65 t/m³. Result: The 1.9 m³ bucket carries 2.0 m³. For optimal stability always consult the bucket selection chart.

Material	Bucket fill, %	Material density, t/m ³	ISO/SAE bucket volume, m ³	Actual volume, m ³
Earth/Clay	~ 110	~ 1.55	2.1	2.3
		~ 1.45	2.3	2.5
		~ 1.40	2.4	2.6
Sand/Gravel	~ 105	~ 1.60	2.1	2.2
		~ 1.50	2.3	2.4
		~ 1.45	2.4	2.5
Aggregate	~ 100	~ 1.80	2.1	2.1
		~ 1.70	2.3	2.3
		~ 1.60	2.4	2.4
Rock	≤100	~ 1.70	1.6	1.6

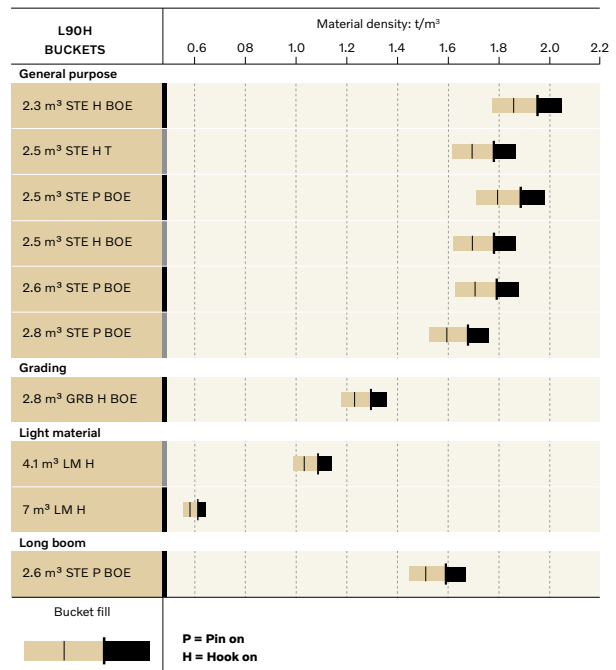

How to read bucket fill factor

Supplemental Operating Data

Tires 20.5 R25 L3	Standard boom		Long boom
	20.5 R25 L2	650/65 R25 L3	650/65 R25 L3
Width over tires	mm	+4	+164
Ground clearance	mm	-8	+12
Tipping load, full turn	kg	-70	+287
Operating weight	kg	-111	+545

Calculated with 2.6 m³ STE P BOE, additional protective guarding

Equipment

STANDARD EQUIPMENT			
	L60H	L70H	L90H
Engine			
Exhaust after-treatment system	•	•	•
3-stage air cleaner, pre-cleaner, primary and secondary filter	•	•	•
Indicator glass for coolant level	•	•	•
Preheating of induction air	•	•	•
Fuel pre-filter with water trap	•	•	•
Fuel filter	•	•	•
Crank case breather oil trap	•	•	•
Exhaust heat ventilation	•	•	•
Tires			
17.5R25	•	–	–
20.5R25	•	•	•
Drivetrain			
Automatic Power Shift	•	•	•
Fully automatic gear shifting, 1-4	•	•	•
PWM-controlled gear shifting	•	•	•
Forward and reverse switch by hydraulic lever console	•	•	•
Indicator glass for transmission oil level	•	•	•
Differentials: Front, 100% hydraulic diff lock. Rear, conventional	•	•	•
Electrical system			
24 V, pre-wired for optional accessories	•	•	•
Alternator 80A/3135W	•	•	•
Battery disconnect switch	•	•	•
Maintenance-free batteries	•	•	•
Battery box, steel	•	•	•
Fuel gauge	•	•	•
Electric horn	•	•	•
Instrument cluster:			
Fuel level	•	•	•
Diesel Exhaust Fluid/AdBlue level	•	•	•
Transmission temperature	•	•	•
Coolant temperature	•	•	•
Instrument lighting	•	•	•
Lighting:			
Twin halogen front headlights with high and low beams	•	•	•
Parking lights	•	•	•
Double brake and tail lights	•	•	•
Turn signals with flashing hazard light function	•	•	•
Halogen work lights (2 front and 2 rear)	•	•	•

STANDARD EQUIPMENT			
	L60H	L70H	L90H
Contronic monitoring system			
Contronic display	•	•	•
Fuel consumption	•	•	•
Diesel Exhaust Fluid/AdBlue consumption	•	•	•
Ambient temperature	•	•	•
Clock	•	•	•
Test function for warning and indicator lights	•	•	•
Brake test	•	•	•
Warning and indicator lights:			
Battery charging	•	•	•
Parking brake	•	•	•
Warning and display message:			
Regeneration	•	•	•
Engine coolant temperature	•	•	•
Charge air temperature	•	•	•
Engine oil temperature	•	•	•
Engine oil pressure	•	•	•
Transmission oil temperature	•	•	•
Transmission oil pressure	•	•	•
Hydraulic oil temperature	•	•	•
Brake pressure	•	•	•
Parking brake applied	•	•	•
Brake charging	•	•	•
Overspeed at direction change	•	•	•
Axle oil temperature	•	•	•
Steering pressure	•	•	•
Crank case pressure	•	•	•
Attachment lock open	•	•	•
Level warnings:			
Fuel level	•	•	•
Diesel Exhaust Fluid/AdBlue level	•	•	•
Engine coolant level	•	•	•
Transmission oil level	•	•	•
Hydraulic oil level	•	•	•
Washer fluid level	•	•	•
Engine torque reduction in case of malfunction indication:			
High engine coolant temperature	•	•	•
High engine oil temperature	•	•	•
Low engine oil pressure	•	•	•
High crank case pressure	•	•	•
High charge air temperature	•	•	•
Engine shutdown to idle in case of malfunction indication:			
High transmission oil temperature	•	•	•
Slip in transmission clutches	•	•	•
Key pad, background lit	•	•	•
Start interlock when gear is engaged	•	•	•

STANDARD EQUIPMENT			
	L60H	L70H	L90H
Hydraulic system			
Main valve, double acting 2-spool with hydraulic pilots	•	•	•
Variable displacement axial piston pumps (2) for:			
Working hydraulics, pilot hydraulics, steering system, brakes	•	•	•
Cooling fan, brakes	•	•	•
Hydraulic control levers	•	•	•
Mechanical hydraulic lever lock	•	•	•
Automatic boom kick-out	•	•	•
Automatic bucket positioner	•	•	•
Double acting hydraulic cylinders	•	•	•
Indicator glass for hydraulic oil level	•	•	•
Hydraulic oil cooler	•	•	•
Brake system			
Dual brake circuits	•	•	•
Dual brake pedals	•	•	•
Secondary brake system	•	•	•
Parking brake, electrical-hydraulic	•	•	•
Brake wear indicators	•	•	•
Outboard mounted circulating oil cooled wet disc brakes on all four wheels	•	•	•
Cab			
ROPS (ISO 3471), FOPS (ISO 3449)	•	•	•
Single key kit door/start	•	•	•
Acoustic inner lining	•	•	•
Cigarette lighter, 24 V power outlet	•	•	•
Lockable door	•	•	•
Cab heating with fresh air inlet and defroster	•	•	•
Fresh air inlet with two filters	•	•	•
Automatic heat control	•	•	•
Floor mat	•	•	•
Dual interior lights	•	•	•
Interior rearview mirrors	•	•	•
Dual exterior rearview mirrors	•	•	•
Sliding window, right side	•	•	•
Tinted safety glass	•	•	•
Retractable seatbelt (SAE J386)	•	•	•
Adjustable steering wheel	•	•	•
Storage compartment	•	•	•
Document pocket	•	•	•
Sun visor	•	•	•
Beverage holder	•	•	•
Windshield washer front and rear	•	•	•
Windshield wipers front and rear	•	•	•
Interval function for front and rear wipers	•	•	•
Foot step, left side (toolbox lockable included)	•	•	•
Service and maintenance			
Engine oil remote drain and fill	•	•	•
Transmission oil remote drain and fill	•	•	•
Sliding hydraulic oil cooler and AC-condenser	•	•	•
Lubrication manifolds, ground accessible	•	•	•
Pressure test ports: transmission and hydraulic, quick connects	•	•	•
Service platforms with anti-slip surfaces	•	•	•
CareTrack	•	•	•
Telematics, 6 -year subscription	•	•	•
Toolbox, lockable	•	•	•
External equipment			
Basic fenders, front and rear	•	•	•
Viscous cab mounts	•	•	•
Rubber engine and transmission mounts	•	•	•
Engine hood, electronically openable	•	•	•
Frame, joint lock	•	•	•
Vandalism lock for engine compartment	•	•	•
Lifting eyes	•	•	•
Tie down eyes	•	•	•
Tow hitch	•	•	•
Counterweight, pre-drilled for optional guards	•	•	•

OPTIONAL EQUIPMENT			
	L60H	L70H	L90H
Engine			
Air pre-cleaner, cyclone type	•	•	•
Air pre-cleaner, oil-bath type	•	•	•
Air pre-cleaner, turbo type	•	•	•
Engine auto shut down	•	•	•
Engine block heater, 120V / 230V	•	•	•
Fuel heater	•	•	•
Fuel fill strainer	•	•	•
Hand throttle control	•	•	•
Max. fan speed, hot climate	•	•	•
Reversible cooling fan	•	•	•
Drivetrain			
Lock-up torque converter	•	•	•
Rear axle with limited slip	•	•	•
Speed limiter, 20 km/h	•	•	•
Speed limiter, 30 km/h	•	•	•
Speed limiter, 40 km/h	•	•	•
Hydraulic system			
Arctic kit: Attachment locking, pilot hoses and hydraulic oil	•	•	•
Attachment bracket, cast, visibility-optimized	•	•	•
Attachment bracket, side-tilting	•	•	•
Separate attachment locking, long boom	•	•	•
Separate attachment locking, standard boom	•	•	•
Single acting lifting function	•	•	•
Boom suspension system	•	•	•
HD load-sensing hydraulics, pump kit included	–	•	–
Hydraulic fluid, biodegradable, Volvo	•	•	•
Hydraulic fluid, fire resistant	•	•	•
Hydraulic fluid, for hot climate	•	•	•
Hydraulic, 3 functions, standard/long boom	•	•	•
Hydraulic, 4 functions, standard/long boom	•	•	•
Detent for 3rd hydraulic function	•	•	•
Adjustable flow for 3rd hydraulic function	•	•	•
Single lever control, 2 functions	•	•	•
Single lever control, 3 functions	•	•	•
Hydraulic, 2 functions Electro-servo, std/long boom	•	•	•
Hydraulic, 3 functions Electro-servo, std/long boom	•	•	•
Hydraulic, 4 functions Electro-servo, std/long boom	•	•	•
Single lever control, 2 funct Electro-servo, std/long boom	•	•	•
Single lever control, 3 funct Electro-servo, std/long boom	•	•	•
Single lever control, 4 funct Electro-servo, std/long boom	•	•	•
Brake system			
Stainless steel, brake lines	–	•	•
Parking brake alarm, audible	•	•	•

Equipment

OPTIONAL EQUIPMENT			
	L60H	L70H	L90H
Cab			
ACC control panel, with Fahrenheit scale	•	•	•
Anchorage for Operator's manual	•	•	•
Asbestos dust protection filter	•	•	•
Automatic Climate Control, ACC	•	•	•
Automatic Climate Control, ACC, corrosion protection condenser	•	•	•
Cab air pre-cleaner, cyclone type	•	•	•
Carbon filter - cab	•	•	•
Remote door opener	•	•	•
Lunch box holder	•	•	•
Operator's seat, Volvo air-suspended, heavy-duty, high back, heated	•	•	•
Operator's seat, Volvo air-susp, 3-point seatbelt	•	•	•
Operator's seat, ISRI, heated, high back	•	•	•
Operator's seat, ISRI, low back	•	•	•
Operator's seat, Premium Comfort ISRI	•	•	•
Armrest, operator's seat, ISRI, left only	•	•	•
Armrest, operator's seat, Volvo, left	•	•	•
Safety belt, 3" (75mm) width	•	•	•
Safety belt warning	•	•	•
Radio installation kit including 12 volt outlet, left-side	•	•	•
Radio installation kit including 12 volt outlet, right-side	•	•	•
Radio installation kit, 12V, for USA	•	•	•
Radio with AUX, Bluetooth and USB connection	•	•	•
Subwoofer	•	•	•
Forward view mirror	•	•	•
Rear view mirrors, el.adjusted and heated	•	•	•
Rear view mirrors, long arm right	•	•	•
Rear view mirrors, el.adjusted and heated, long arm right	•	•	•
Steering wheel knob	•	•	•
Sun blinds, rear windows	•	•	•
Sun blinds, side windows	•	•	•
Timer cab heating	•	•	•
Universal door/ignition key	•	•	•
Window, sliding, door	•	•	•
Service and maintenance			
Automatic lubrication system	•	•	•
Automatic lubrication system for long boom	•	•	•
Oil sampling valve	•	•	•
Refill pump for automatic lubrication system	•	•	•
Tool kit	•	•	•
Wheel nut wrench kit	•	•	•

OPTIONAL EQUIPMENT			
	L60H	L70H	L90H
Electrical			
Battery disconnect switch, additional in cab	•	•	•
Anti-theft device	•	•	•
Headlights, assym. left	•	•	•
Headlights, assym. right LED	•	•	•
Headlights, assym. left LED	•	•	•
Emergency stop	•	•	•
License plate holder, lighting	•	•	•
Reduced function working lights when reverse gear activated	•	•	•
Side marker lamps	•	•	•
Forward camera, colour	•	•	•
Rear view camera including monitor, colour	•	•	•
Rear view mirrors, long arm, right side	•	•	•
Rearview mirrors, adjustable, el. heated	•	•	•
Reverse alarm	•	•	•
Reverse lights	•	•	•
Reversing warning light	•	•	•
Reverse warning light, strobe lightning	•	•	•
Warning beacon (flasher), LED automatic	•	•	•
Warning beacon (flasher), LED	•	•	•
Working lights, attachments, 1 LED	•	•	•
Working lights, attachments	•	•	•
Economy LED-light package	•	•	•
Feature LED-light package	•	•	•
Power LED-light package	•	•	•
Working lights front, on cab, dual	•	•	•
Working lights rear, on cab	•	•	•
Working lights rear, on cab, dual	•	•	•
Working lights front, extra	•	•	•
Working lights, front on cab, 2 LED lamps	•	•	•
Working lights, rear on cab, 2 LED lamps	•	•	•
Working lights, front on cab, 4 LED lamps	•	•	•
Working lights, rear on cab, 4 LED lamps	•	•	•
Working lights, side on cab, 4 LED lamps	•	•	•
Working lights, rear in grille, 2 LED lamps	•	•	•
Working lights, front above head lamps, 2 LED lamps	•	•	•
Taillight, LED lamp	•	•	•
Protective equipment			
Anti-theft device	•	•	•
Bellyguard front	•	•	•
Bellyguard rear	•	•	•
Boom cylinder hose and tube guards	•	•	•
Cab roof, heavy duty	•	•	•
Center hinge and rear frame guard	•	•	•
Corrosion protection, painting of machine	•	•	•
Cover plate front frame, heavy-duty	•	•	•
Cover plate, under cab	•	•	•
Cover plates rear frame	•	•	•
Guards for front headlights	•	•	•
Grease nipple guards	–	•	•
Guards for radiator grill	•	•	•
Guards for tail lights, heavy-duty	•	•	•
Wheel/axle seal guards	•	•	•
Window guards, side and rear	•	•	•
Windshield guard	•	•	•

OPTIONAL EQUIPMENT			
	L60H	L70H	L90H
External equipment			
Deleted front mudguards	•	•	•
Fire extinguisher	•	•	•
Bracket for fire extinguisher	•	•	•
Fire suppression system	•	•	•
Mudguards, full cover, rear for 80-series tires	•	•	•
Mudflap kit for mudguards, full cover for 80-series tires	•	•	•
Mudguards, full cover, rear and front/rear for 65-series tires	•	•	•
Mudflap kit for mudguards, full cover for 65-series tires	•	•	•
Footsteps front frame	•	•	•
Footsteps, right-hand side	•	•	•
Flexible rear step	•	•	•
Cab ladder, rubber suspended	•	•	•
Other equipment			
CareTrack, GSM/Satellite	•	•	•
CE-marking	•	•	•
Comfort Drive Control (CDC)	•	•	•
Comfort Drive Control (CDC) Electro-servo	•	•	•
Secondary steering	•	•	•
Counterweight, logging	•	•	•
Noise reduction kit, Blauer Engel including decal	•	•	•
Noise reduction kit, EU excluding decal	•	•	•
Sign, 50 km/h	•	•	•
Sign, slow moving vehicle	•	•	•

OPTIONAL EQUIPMENT			
	L60H	L70H	L90H
Tires and Rims			
17.5R25	•	–	–
20.5R25	•	•	•
600/65R25	•	•	•
650/65R25	–	–	•
620/75R26 Agriculture application only	•	•	•
750/65R26 Agriculture application only	•	•	•
Attachments			
Buckets:			
Straight	•	•	•
Spade nose	•	•	•
High tipping	•	•	•
Light material	•	•	•
Grading	•	•	•
Wear parts:			
Bolt-on edge	•	•	•
Bolt-on or weld-on bucket teeth	•	•	•
Segments	•	•	•
Log grapples	•	•	•
Fork equipment	•	•	•
Material handling arm	•	•	•
Snow blade	•	•	•
Broom	•	•	•
Sand spreading bucket	•	•	•
Bale clamp	•	•	•
Drum rotator	•	•	•

SELECTION OF VOLVO OPTIONAL EQUIPMENT

External axle cooling (L70H, L90H)



Reversing camera with radar detect



Premium seat



Comfort Drive Control



Light packages



Lock-up converter



Not all products are available in all markets. Under our policy of continuous improvement, we reserve the right to change specifications and design without prior notice. The illustrations do not necessarily show the standard version of the machine.

VOLVO

Volvo Construction Equipment

volvo.com